



LD Series

5-100 kN Materials Testing



When Only the Best is Good Enough

Quality and Integrity are Part of Our DNA.

Over half a century, Lloyd Instruments has designed and built high quality materials testing instruments for companies all over the world. We strive to provide our customers the very best user experience, and take pride in working with each one to help tailor testing solutions to meet their specific needs.

To ensure you receive an accurate, reliable instrument of the highest quality, Lloyd Instruments test machines are designed and handcrafted at our factories in the United States in accordance with ISO 9001. The test machines are CE certified and supported by our global service centres in accordance to ISO 17025.

Quality and integrity are part of our DNA, and we would like to help make it a part of yours as well.

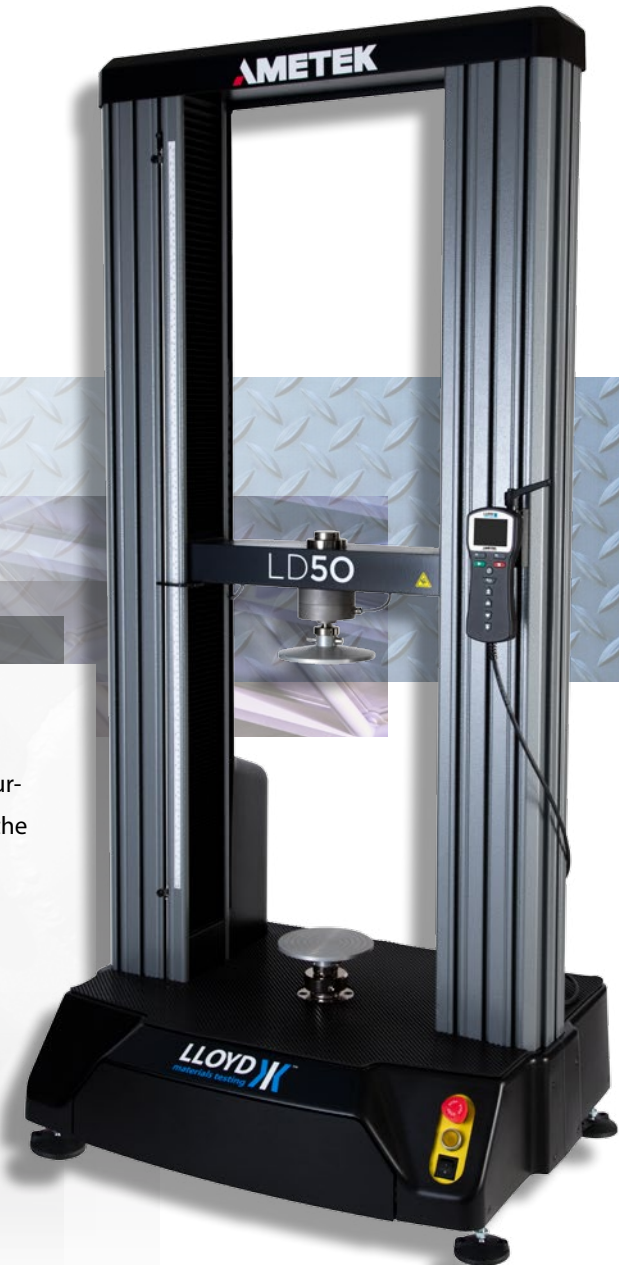

A Complete Testing Solution

The LD Series offers a complete testing solution. Extensive support after the purchase guarantees that you will have a working partner for as long as you own the instrument. With a testing solution from Lloyd Instruments you will get:

- Quality products
- Accuracy and consistency in your test results
- Flexibility to amend your machine to match new needs
- Adherent to international test methods such as ASTM and ISO
- Full range of grips, fixtures, safety shields and thermal chambers for all types of applications



Cost Effective

Save Money – It's All Included

Optimizing and improving systems to keep up with a constantly changing testing landscape (new materials, stricter regulations, demands for more efficient workflows) along with technical support, can have a significant impact on the cost of any materials testing solution over time. Poorly built machines and accessories may have short lifecycles, so quality and integrity are also important considerations when making this critical investment. Financial unpredictability can be a burden on your budget; and hidden costs can turn a bargain solution into a costly mistake.

When purchasing a materials testing solution from Lloyd Instruments all available software modules are included in the price, and extensive technical and application support is provided for the standard tests supplied. If your testing needs change, the universal LD test machine enables easy change of grips to suit any application needed while the flexibility of the NEXYGEN^{Plus} 4 software offers a large library of test setups to choose from. This is what we call an **All Inclusive** testing experience.

- ☐ Tensile Strength
- ☐ Flexure / Bend Strength
- ☐ Puncture Strength
- ☐ Peel Strength
- ☐ Delamination Strength
- ☐ Adhesion Strength
- ☐ Creep and Stress Relaxation
- ☐ Deformation Strength
- ☐ Elastic Limit
- ☐ Rupture Strength
- ☐ Toughness
- ☐ Compression
- ☐ Coefficient of Friction
- ☐ Tear Resistance
- ☐ Shear Strength
- ☐ Bond Strength
- ☐ Break Load
- ☐ Crush Resistance
- ☐ Ductility
- ☐ Elongation
- ☐ Young's Modulus
- ☐ Torsion

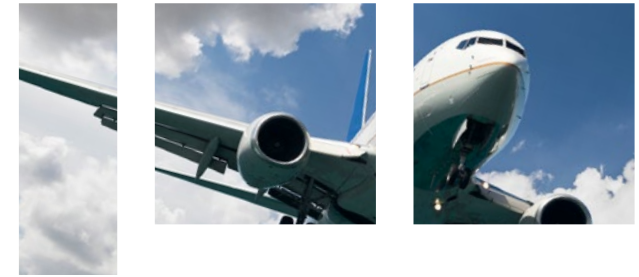

All Inclusive Systems

Everything you will need ◀

With the all inclusive solution from Lloyd Instruments you get:

- High quality materials testing machine
- Flexible software
- Extensive library of test setups adherent to relevant international standards
- Technical and application support

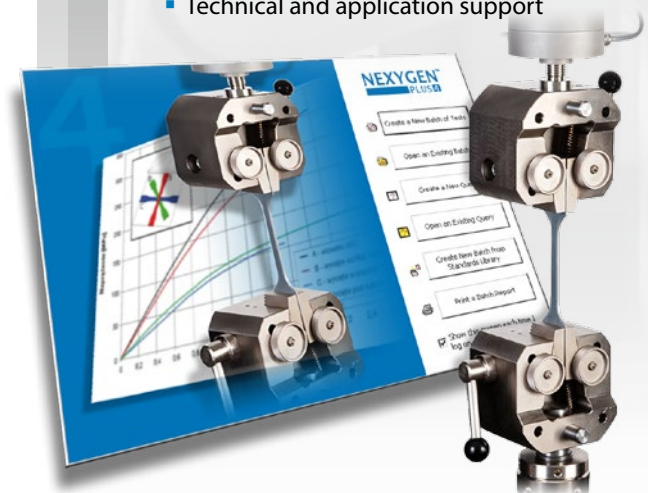

Strength & Accuracy

Optimized for Automated Testing

Take your testing to new levels of flexibility and productivity. High precision LD Series materials testers are designed to automate your workflow, helping to reduce costs and save time, while providing high precision, accuracy, and reliability.

A CANBUS interface provides fast, accurate communication between the LD Series and add-on accessories like robots, extensometers, and temperature chambers. Your test results are automatically uploaded to the advanced NEXYGEN*Plus* 4 software for easy analysis. With the LD Series automated testing capabilities, repetitive tests can be run in hours rather than days, helping to eliminate operator error and improve operator safety.

Applications for a Variety of Industries



A Flexible Future

The LD Series' modular design allows you the flexibility to customize your testing experience, ensuring that your material tester will meet your needs today and into the future. With the availability of thousands of highly accurate, interchangeable grips and fixtures, plus an extensive range of accessories, the LD Series can perform virtually any type of test—quickly, safely, easily, and accurately.



Quality by Design

Designed to Perform. Built to Last.

The advanced dual column LD Series materials testers incorporate an extensive range of features, making them ideal for performing both routine and complex tests up to 100 kN. The robust design, featuring ultra-stiff frames to minimize deflection and a low, rugged base offer unprecedented operator safety. Stiffness compensation eliminates compliance in applications where use of an extensometer is not practical.

The advanced electrical design couples a 32-bit A/D converter and high precision AC drive with preloaded ball screws for better displacement accuracy and a wide range of speeds throughout the full load range.

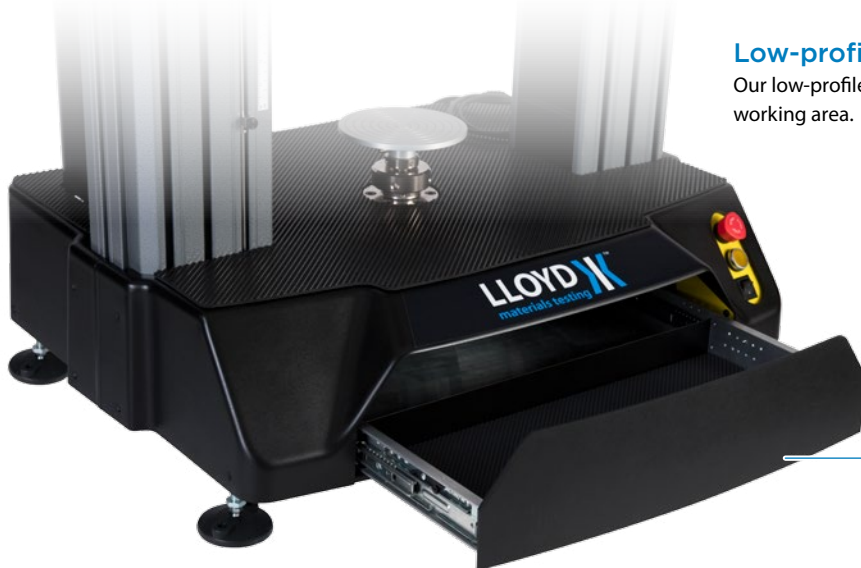

Drawer

A built-in drawer provides a space for tool storage.

Adherent to International Standards

The mechanical design of the LD Series adheres to International standards for industries including metal, composites, automotive, building materials, medical devices, and packaging.

Pancake Load Cells

Pancake load cells improve accuracy at the cross axis and help increase work area.

Low-profile, Rugged Base

Our low-profile base provides a large working area.



Machine Stiffness

Rigid construction provides minimal deflection in the frame and crosshead.

Easy Mounting

T-slots are molded into the aluminum frames to accept accessories like extensometers, splinter shields, and robot arms.

Easy Grip Alignment

With our unique system, fixture and grip alignment is quick and easy.

Crosshead Travel

Standard height to 1070 mm. Extended height to 1669 mm.

Key Features

Simple, Flexible, Powerful.

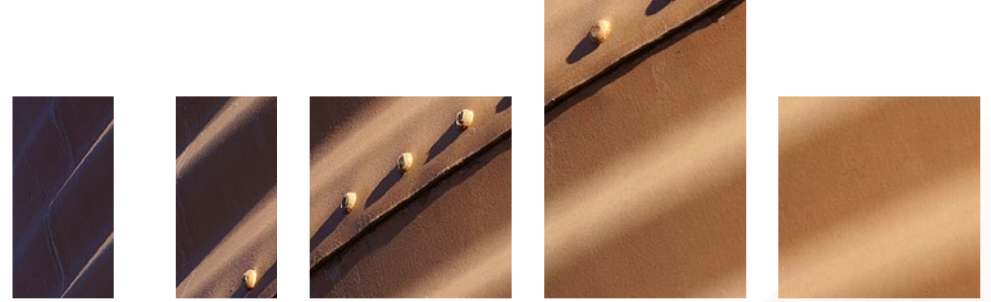

Superior Quality is ensured by using the finest components and assembling the LD Series at our own facilities in the United States.

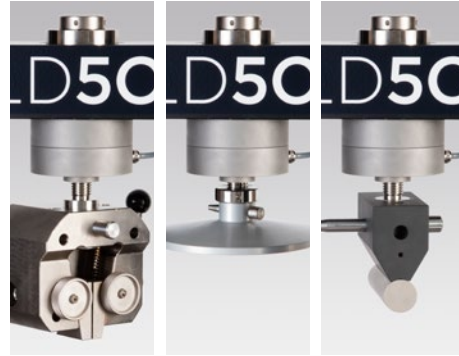

Modular Design featuring interchangeable grips enables use across any industry regardless of sample size, shape, or material.



CANBUS Interface provides fast, accurate communication between the LD Series and add-on accessories like extensometers and temperature chambers.

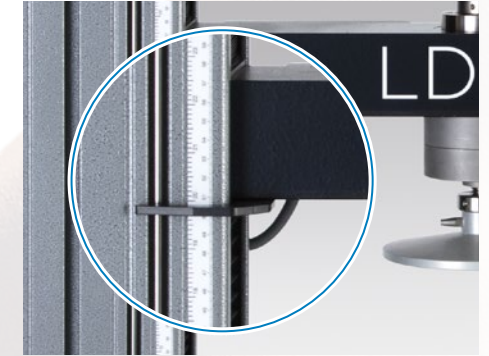

Safety is a priority, and all machines conform to the CE Machinery Directive. Hardware and software overload protection can be configured independently.

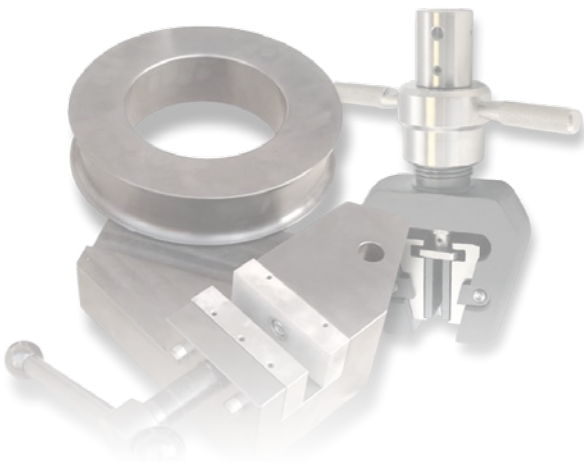

Pancake Load Cells improve accuracy at the cross axis and help increase work area.



AC Drive offers a range of speeds throughout the full load range and high travel resolution.



Preloaded Ball Screws ensure better displacement accuracy.

Accessories

Everything for Precision Testing.



Video Extensometers

VE1 non-contacting video extensometers are based on digital camera and real time image processing. The video extensometer measures longitudinal strain between two applied lines at a rate of up to 100 Hz.



Contacting Extensometers

Contacting extensometers are designed for accurate strain and extension measurement. Long travel extensometers are ideal for testing high-elongation materials. Deflection gauges are ideal for measuring deformation in three and four point bend tests and compression applications.

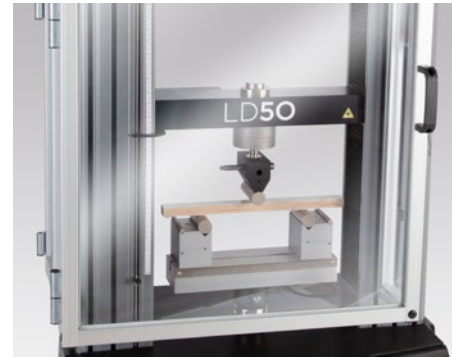

Splinter Shields

Shields for dual column test machines are fully hinged and can be easily adjusted to safely enclose the test area once the sample is positioned. Hinged splinter shields are available in a range of sizes and fully enclose the test area.



Pogos

Our pogo systems are simple to set up and offer a large working area. The test frames are fitted below the machine base to allow testing of very large samples with the added benefit of optional elevated and low temperature testing capacity.

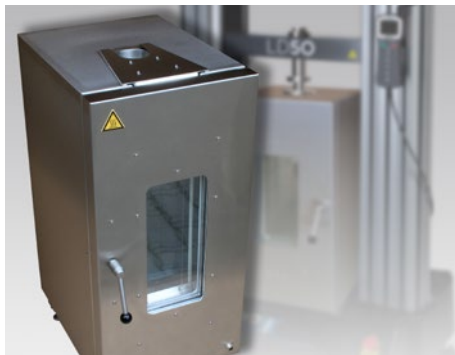

Thermal Cabinets

Cooling and heating cabinets are supplied for testing from -70°C to 300°C . Thermal cabinets are mounted on wheels and feature a glass observation panel in the front door that allows the specimen to be inspected during test.



Work Benches

The rugged benches are suited for heavy test machines. These benches are versatile and easy to move around.

NEXYGEN*Plus* 4

Your Complete Software Solution for Material Tests Today and in the Future

NEXYGEN*Plus* 4 software is the hub of Lloyd Instruments' materials testing systems. It features an extensive library of pre-set test methods that meet domestic and international standards such as ASTM, DIN, EN and ISO along with advanced user configurable test set-ups ideal for product and component testing, R&D use and specialized testing. Easy-to-use NEXYGEN*Plus* 4 software allows an operator to control and monitor all aspects of the system from a single front end, providing fast, reliable, accurate testing and data analysis.

Unique to the NEXYGEN*Plus* 4 software is that all available standard modules and reporting functions are included in the software price. This is what we call an **All Inclusive** testing experience.

“NEXYGEN*Plus* 4 gets the job done easier, faster, and with more flexibility than has ever been possible before.”

Powerful Analysis and Reporting Tools

NEXYGEN*Plus* 4 helps you get the job done easier, faster, and with more flexibility than most other systems on the market. It provides almost unlimited testing and results processing capability in the familiar Excel and Word environment.

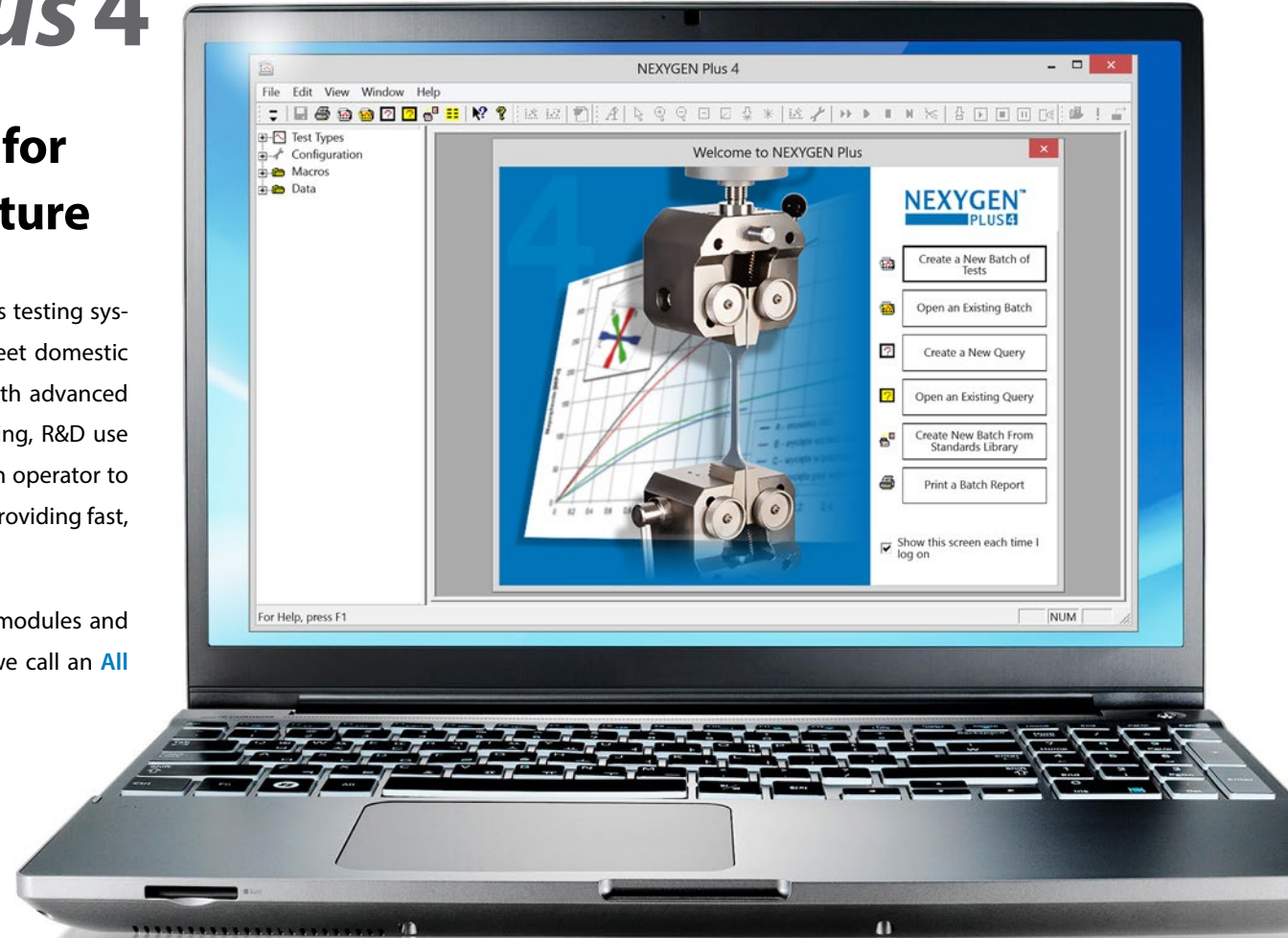

Key Features

Intuitive, Accurate, Automated.



Advanced Multi-Stage Testing is enabled through the User Configurable Test that allows you to quickly build advanced multi-stage test routines using simple built-in commands.

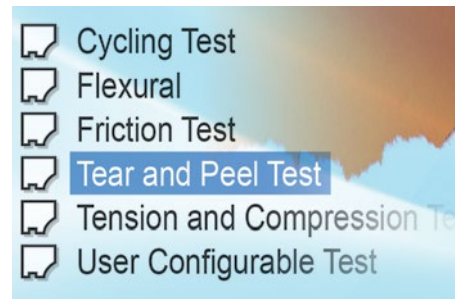

Extensive Test Library is included, so you won't have to purchase extra modules as your testing needs change over time. All tests meet international standards such as ASTM, DIN, EN, and ISO.

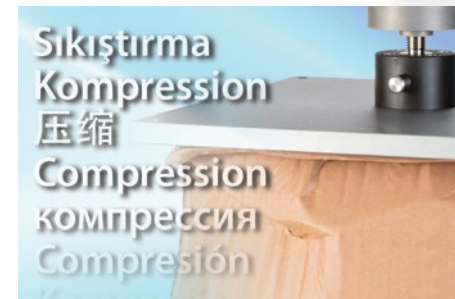

Multi-Lingual functionality gives you the flexibility to work in a number of different languages including English, Spanish, French, German, Italian, Danish, Turkish, Chinese, Russian, and Polish.

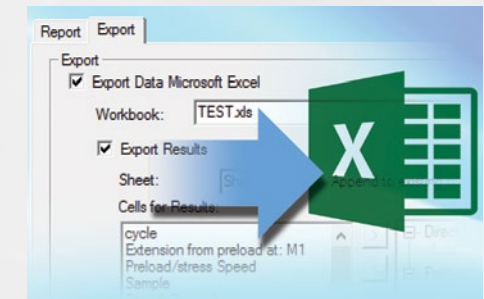

Easy Export to Windows and Excel allow you to import data to company or pre-set NEXYGENPlus 4 templates. Data can be transferred automatically without operator intervention.

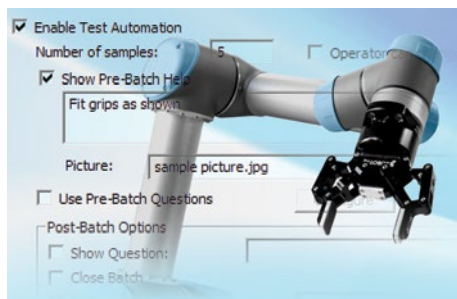

Automated Workflows including automatic reading of sample dimensions and data export of batch tests to Excel are standard features.



Video and Still Capture provide additional analysis features allowing you to examine a sample after the test has been carried out.

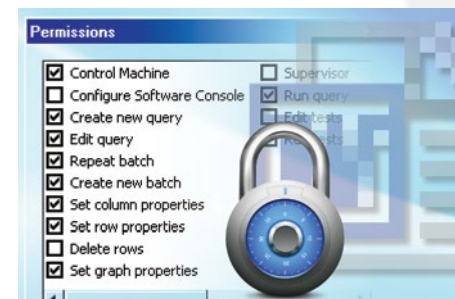

Traceability and Data Integrity is supported by electronic signatures and a configurable feature restricting user access rights.

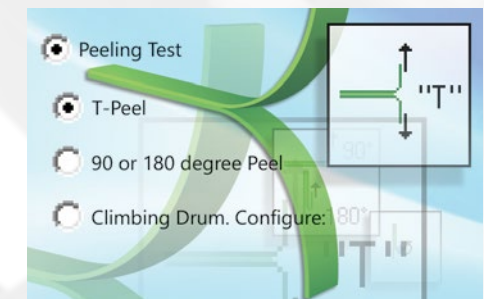

Test Wizards make tension, compression, tearing, peeling, friction, and flexural testing a breeze.

Specifications

Force Capacity

LD5.....	5 kN / 1124 lbf
LD10.....	10 kN / 2248 lbf
LD30.....	30 kN / 6744 lbf
LD50.....	50 kN / 11240 lbf
LD100.....	100 kN / 22480 lbf

Crosshead Speed Range

LD5.....	0.0001 to 1270 mm/min / 0.000004 to 50 in/min
LD10.....	0.0001 to 1270 mm/min / 0.000004 to 50 in/min
LD30.....	0.0001 to 1000 mm/min / 0.000004 to 40 in/min
LD50.....	0.0001 to 500 mm/min / 0.000004 to 20 in/min
LD100.....	0.0001 to 250 mm/min / 0.000004 to 10 in/min

Return Speed

LD5.....	1270 mm/min / 50 in/min
LD10.....	1270 mm/min / 50 in/min
LD30.....	1000 mm/min / 40 in/min
LD50.....	650 mm/min / 26 in/min
LD100.....	325 mm/min / 10 in/min

Speed Accuracy

0.1%

Crosshead Travel

Standard Height.....	1070 mm / 42 in
Extended Height.....	1669 mm / 65.7 in

The LD100 is available in only a standard height version.

Extension Resolution

LD5/10.....	0.000354 micron per encoder count
LD30.....	0.000214 micron per encoder count
LD50.....	0.000121 micron per encoder count
LD100.....	0.000063 micron per encoder count

Load Cell

Load Cell Accuracy.....	< ± 0.5% of reading down to 1/100 of load cell capacity
Resolution.....	32-bit A/D converter
Min. Load Resolution.....	1 part in 10 ⁹

Extensometer Inputs

Analog and Digital

Data Transfer Rate to PC

1 kHz

Supply Voltage

207-253 VAC at 50 Hz or 103.5-126.5 VAC at 60 Hz

Load Measuring System

EN ISO 7500-1:2015, Class 0.5 ASTM E4

Software

NEXYGENPlus 4

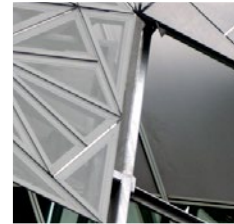

Weight

225 kg / 496 lb

Width Between Columns

452 mm / 17.8 in

Operating Temperature

10-40° C / 50-104° F

Control Modes

Position, Load Rate, and Strain Rate control



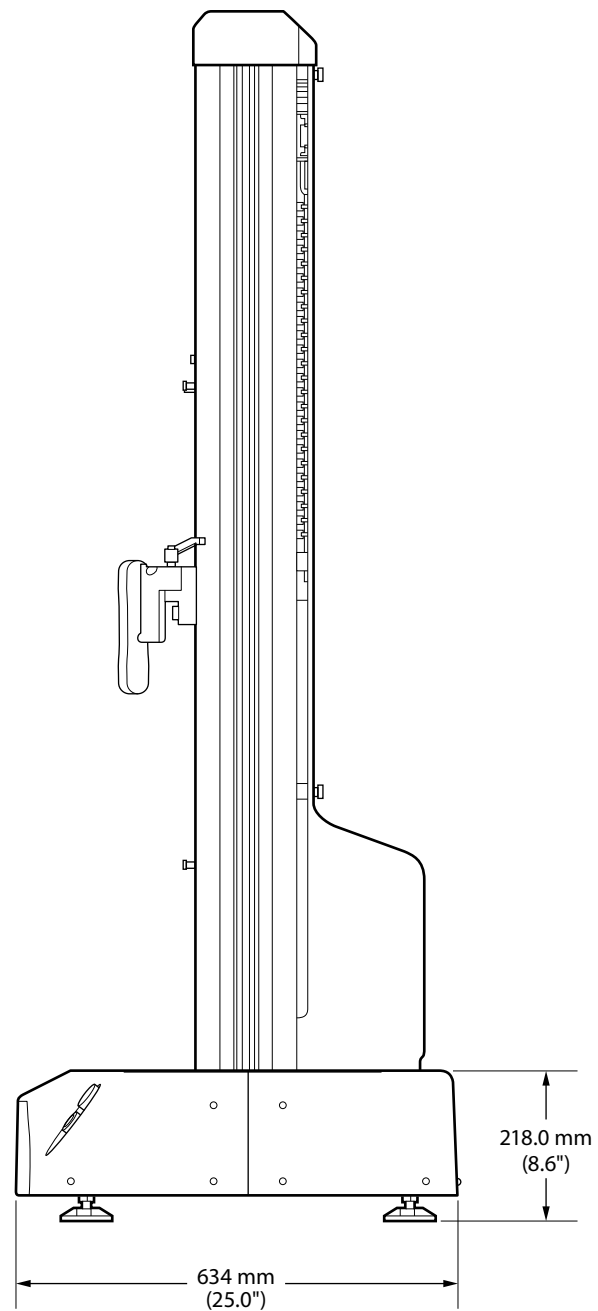
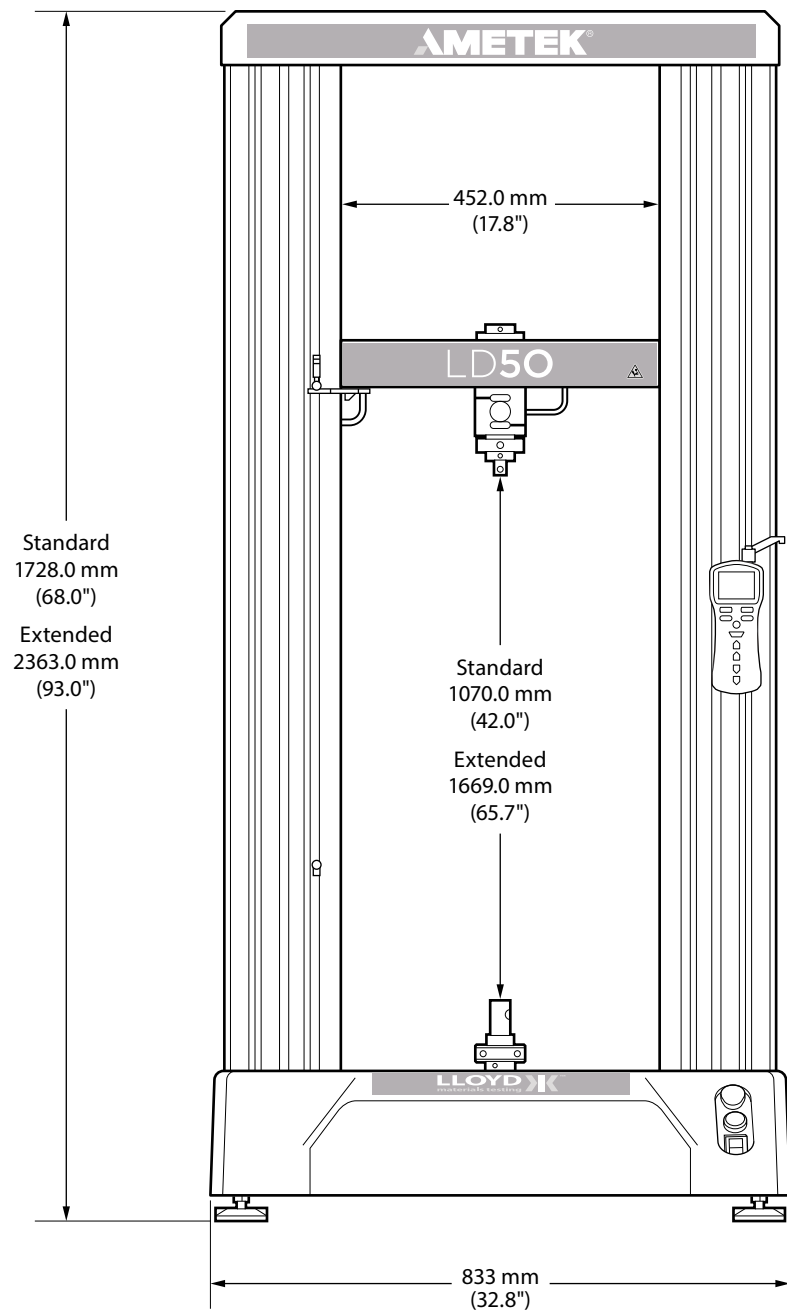

DISTRIBUIDO POR:



Representante México y Centro América:
Ziroba Industrial S.A. De C.V.

Oficinas CDMX
San Juan de Aragón No. 2614
C.P. 07920 Tel. (55) 1114 9464

ventas@ziroba.com
www.ziroba.com

For detailed specifications
go to the Data Sheet at ametekttest.com

LLOYD **K**TM
materials testing

No part of this document may be reproduced or
modified in any form or by any means, electronic
or mechanical, without express written permission
from AMETEK STC.

©2017 AMETEK Incorporated

AMETEK[®]
SENSORS, TEST & CALIBRATION